

RM40

### SISTEMA BATIENTE CÁMARA EUROPEA

\_aperturas: interior, exterior. oscilobatiente, plegable y osciloparalela.

\_dimensiones: marco de 40 mm y hoja de 47 mm.

\_cortes: a inglete.

\_uniones: escuadras de fundición de 14, 26 o 40 mm. de altura.

\_junquillos:

redondeados (clipado o grapa) o recto con cortes a 45° o 90°.

\_acristalamiento:

de 4 a 30 mm.

\_estanqueidad:

triple Junta en EPDM.



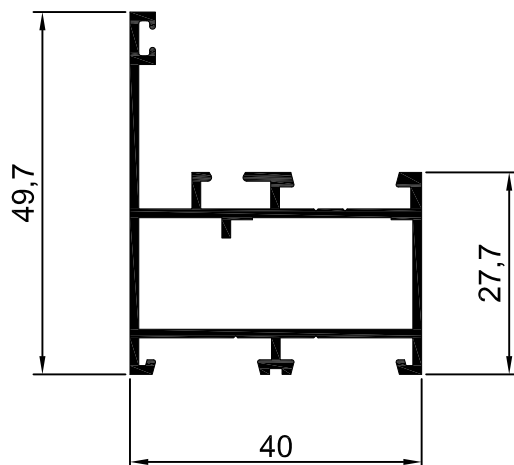

4101  
Cercos de 15 mm

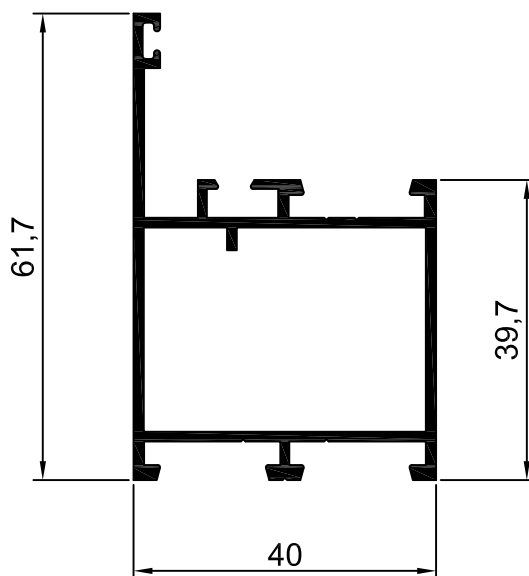

4102  
Cercos de 27 mm

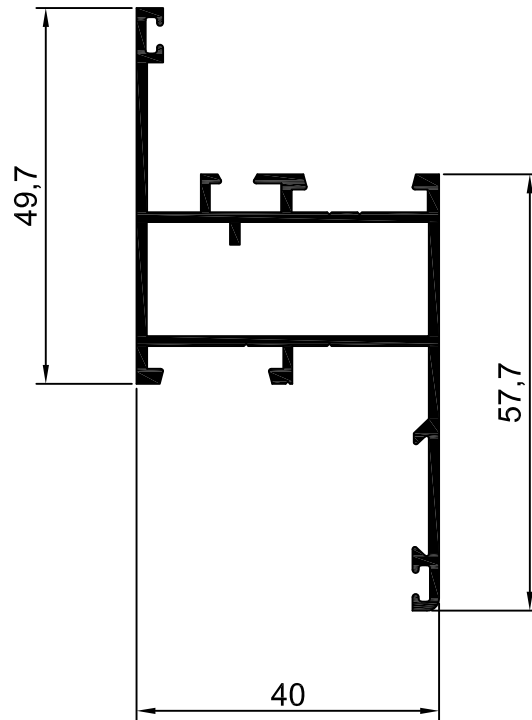

4104  
Cercos de 15 mm  
con Solape

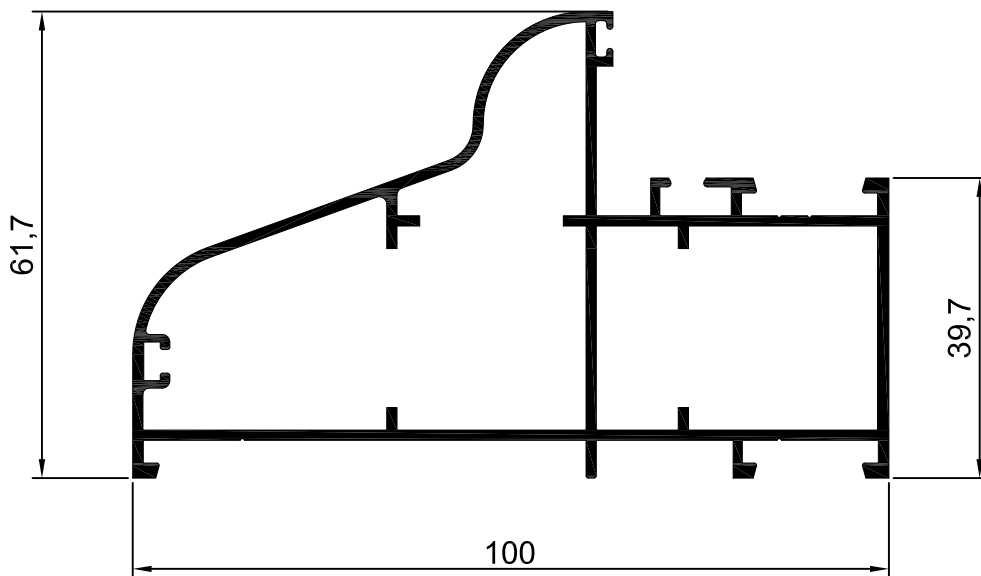

4103  
Cercos Escaparate de 27 mm

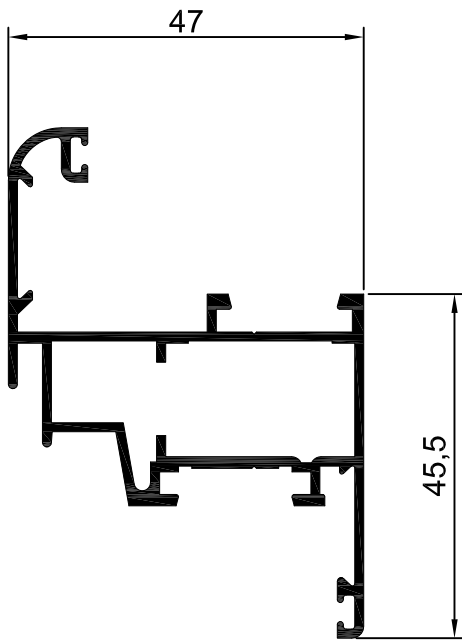

4121  
Hoja Curva de 15 mm

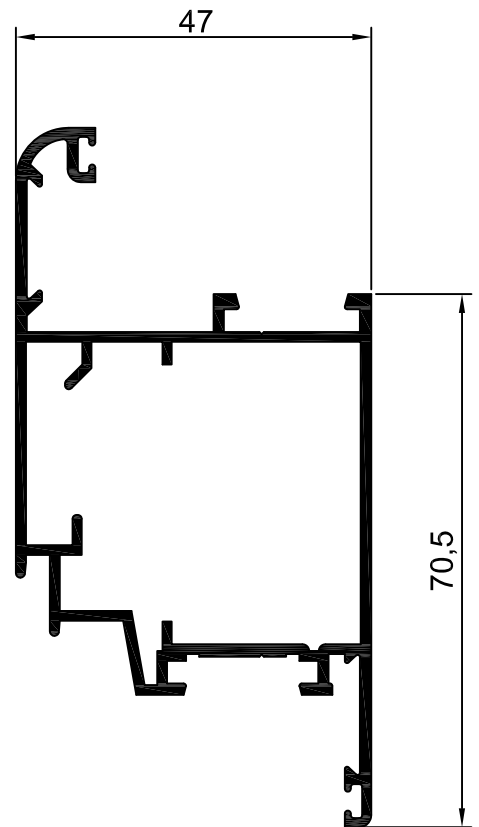

4122  
Hoja Curva de 40 mm

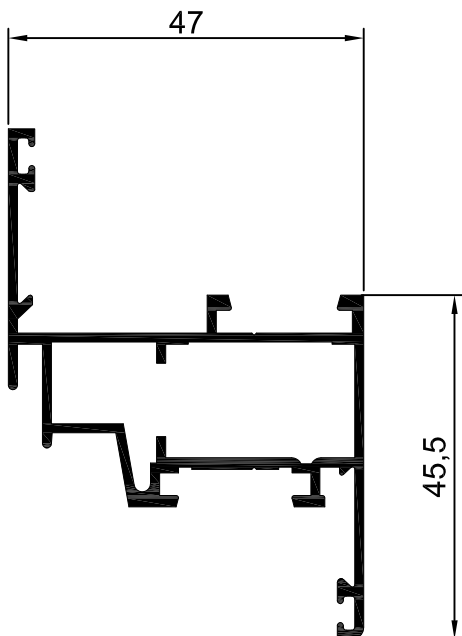

4123  
Hoja Recta de 15 mm

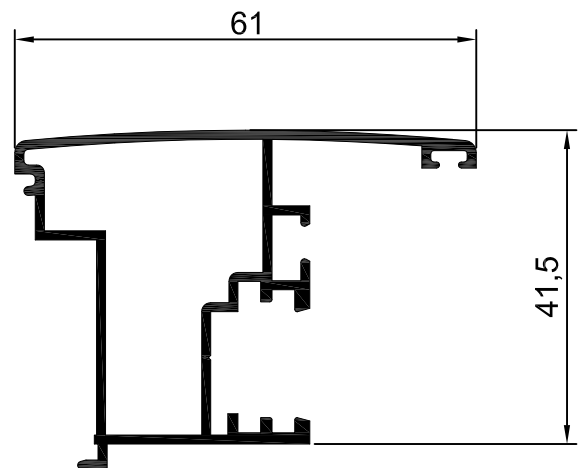

4131  
Inversor

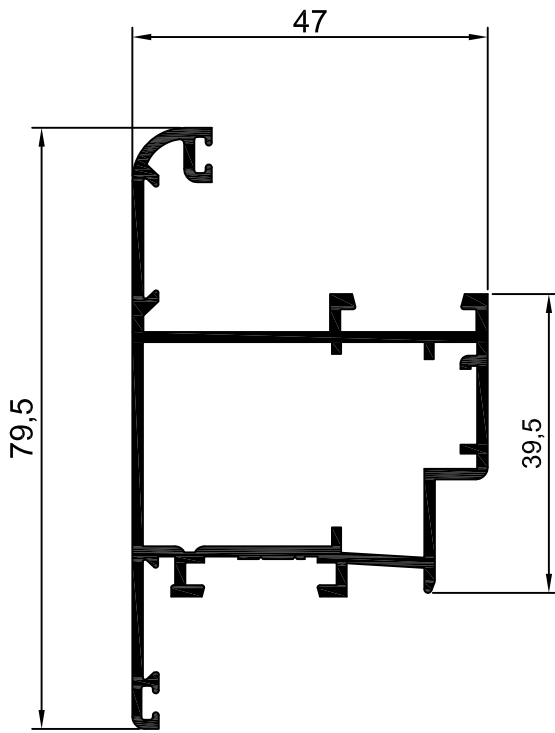

4021  
Hoja Curva de 27 mm  
Apertura Exterior

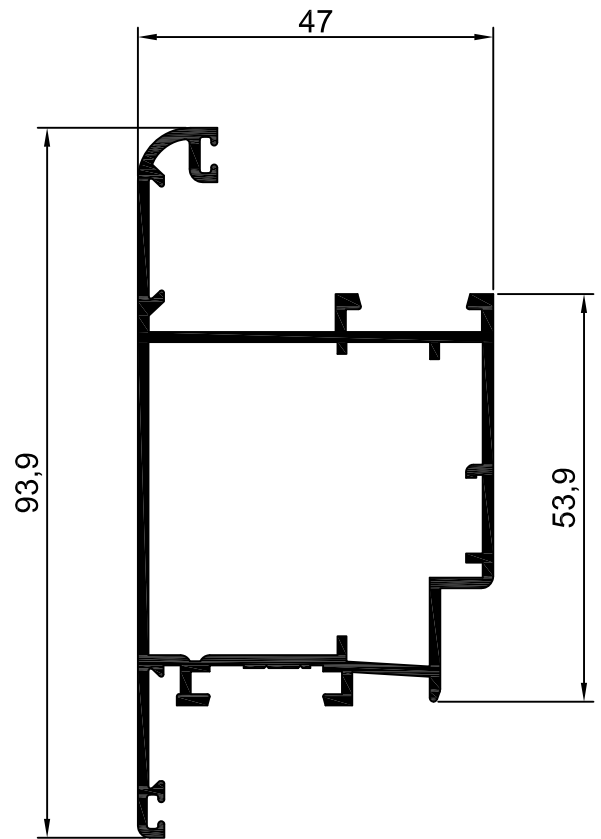

4022  
Hoja Curva de 40 mm  
Apertura Exterior

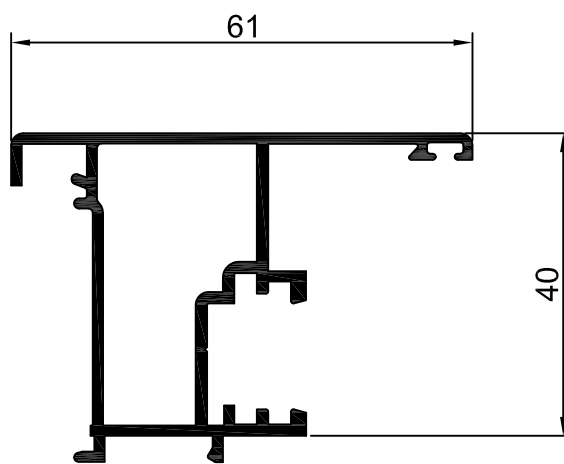

4031  
Inversor

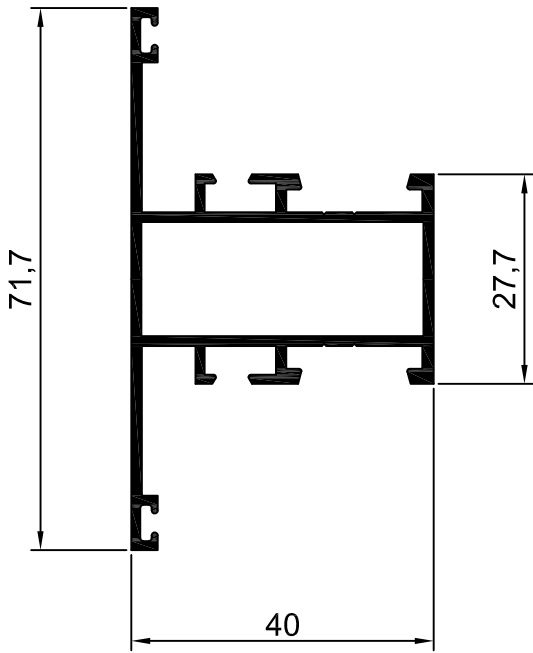

4111  
Travesaño de 72 mm

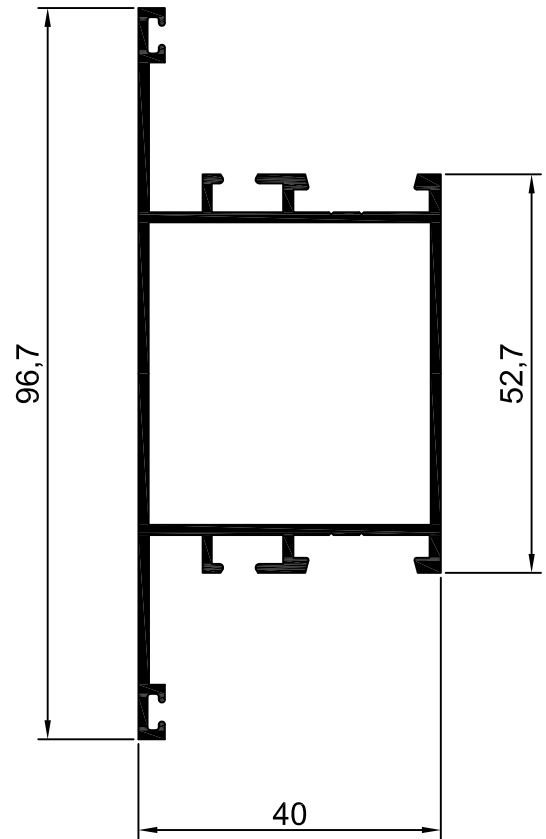

4112  
Travesaño de 97 mm

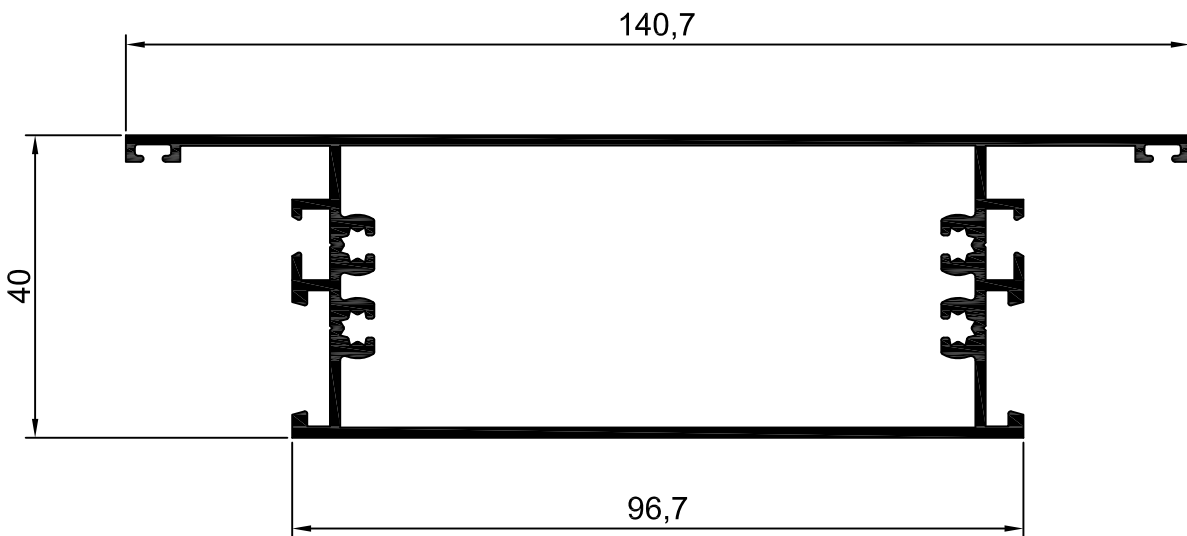

4113  
Travesaño de 140 mm





huevo disponible para vidrio				
REFERENCIA	A	VIDRIO	JUNTA INTERIOR	HUECO
10008	30,4	-	-	6,1
10007	27,4	4	4 mm	9,1
		5	3 mm	
		6	2 mm	
10006	24,4	8	3 mm	12,1
10016				
10056				
10005	21,4	10	4 mm	15,1
10015		12	2 mm	
10055				
10004	18,4	14	3 mm	18,1
10014				
10054				
10003	14,4	16	5 mm	22,1
10013		18	3 mm	
10053				
10002	11,4	20	4 mm	25,1
10012		22	2 mm	
10052				
10001	8,4	24	3 mm	28,1
10000	5,4	26	4 mm	31,1
		28	2 mm	

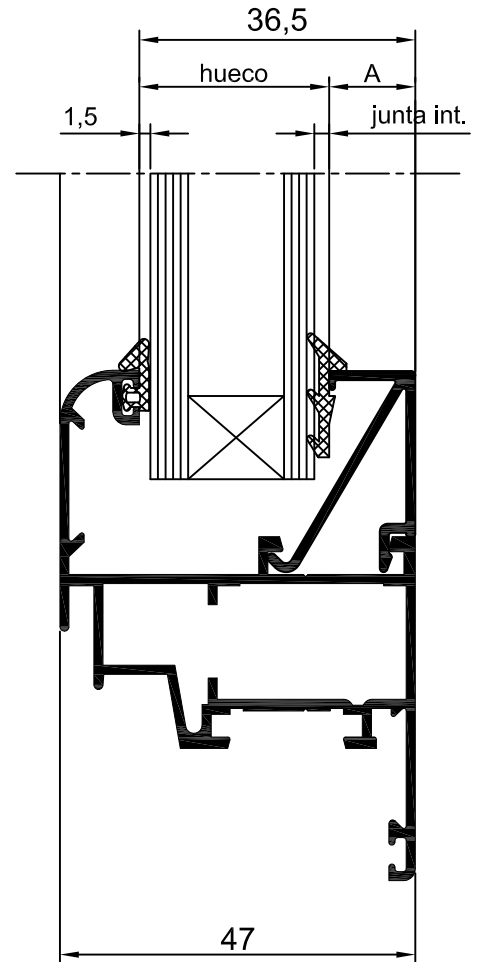

## SITUACION DE LOS CALZOS DE ACRISTALAMIENTO

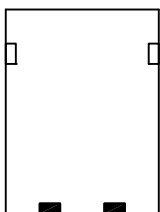

BASTIDOR FIJO

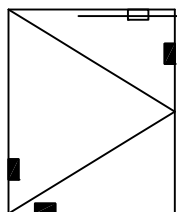

BASTIDOR PRACTICABLE

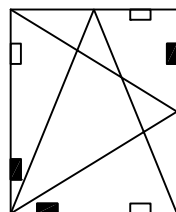

BASTIDOR OSCIOBATIENTE

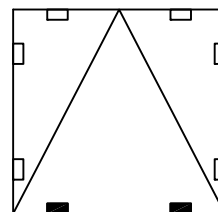

BASTIDOR ABATIBLE

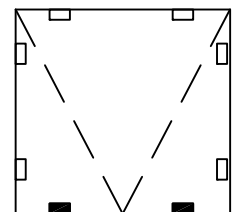

BASTIDOR PROYECTANTE

■ Calzo de apoyo

□ Calzo de colocación

(situar ambos a una distancia de las esquinas de  $L/10$ , siendo L la longitud del lado donde se emplazan)

hueco disponible para vidrio				
REFERENCIA	A	VIDRIO	JUNTA INTERIOR	HUECO
1011	36	-	-	-
1012	31	-	-	5,5
1013	26	4	5	10,5
1021		6	3	
1014	21	8	6	15,5
1022		10	4	
1023		12	2	
1015	18	14	3	18,5
1024		16	3	
1016	11	18	6	25,5
1025		20	4	
		22	2	

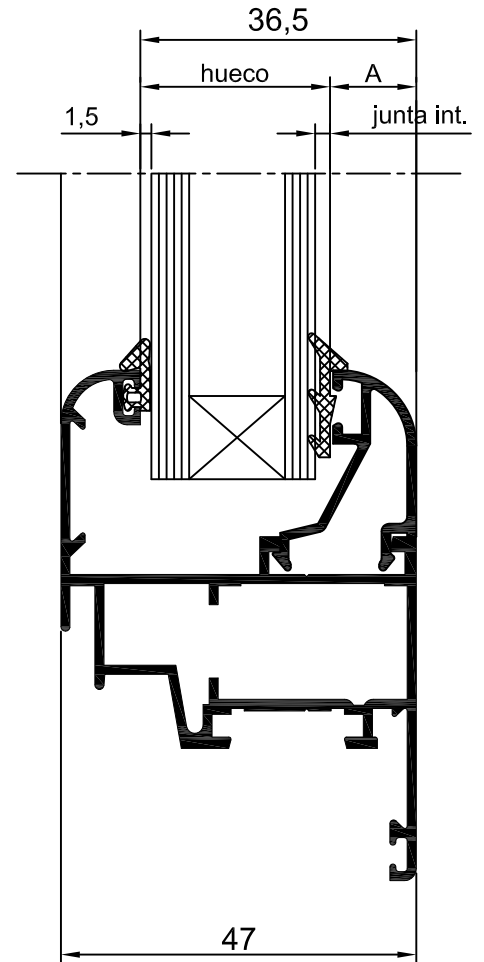

**SITUACION DE LOS CALZOS DE ACRISTALAMIENTO**

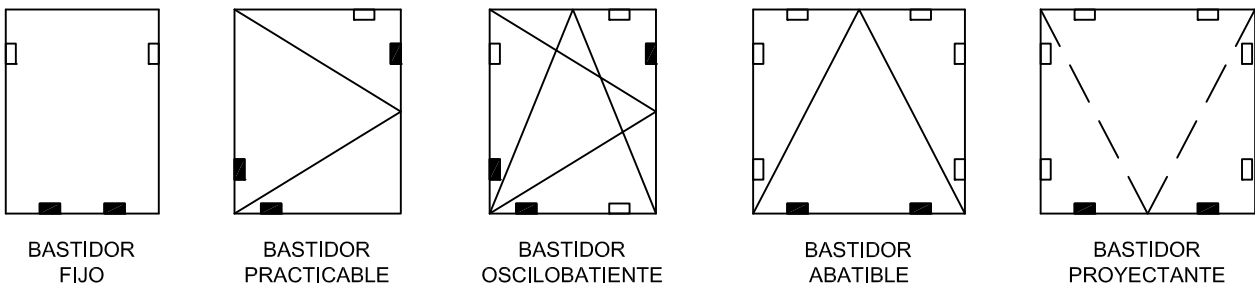

■ Calzo de apoyo

□ Calzo de colocación

(situar ambos a una distancia de las esquinas de L/10, siendo L la longitud del lado donde se emplazan)

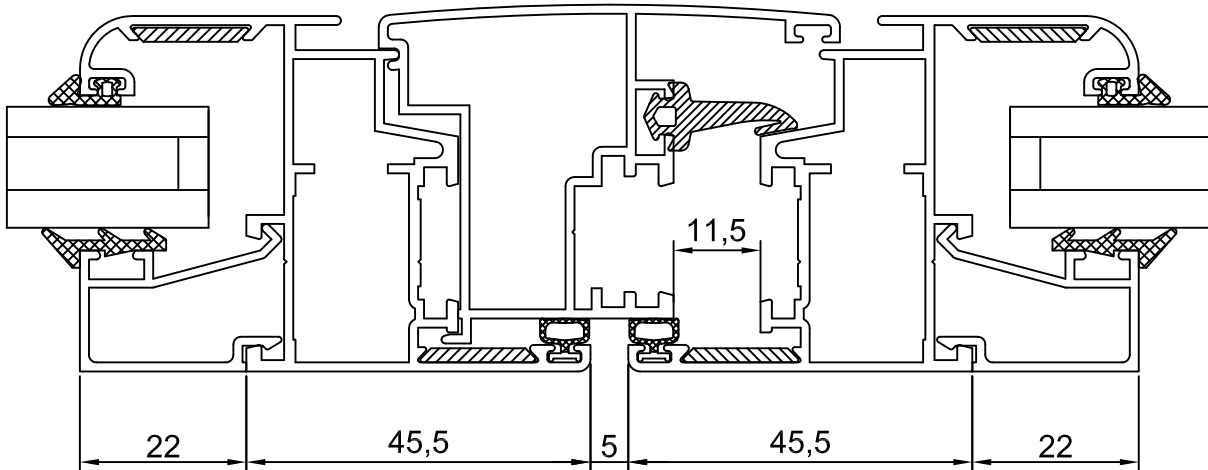
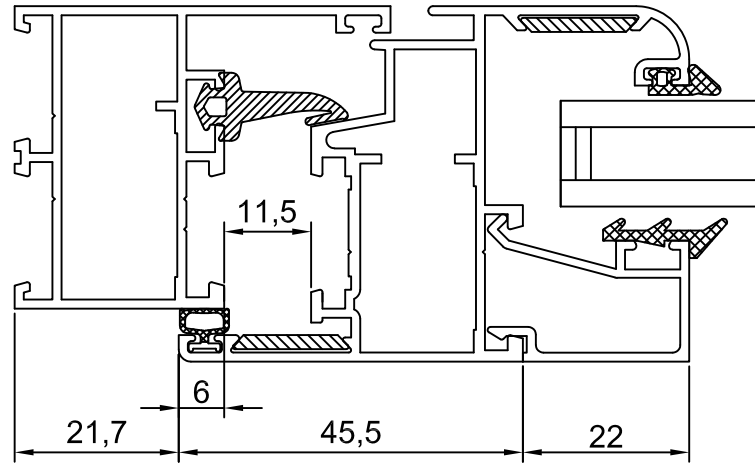

escala  
1:1

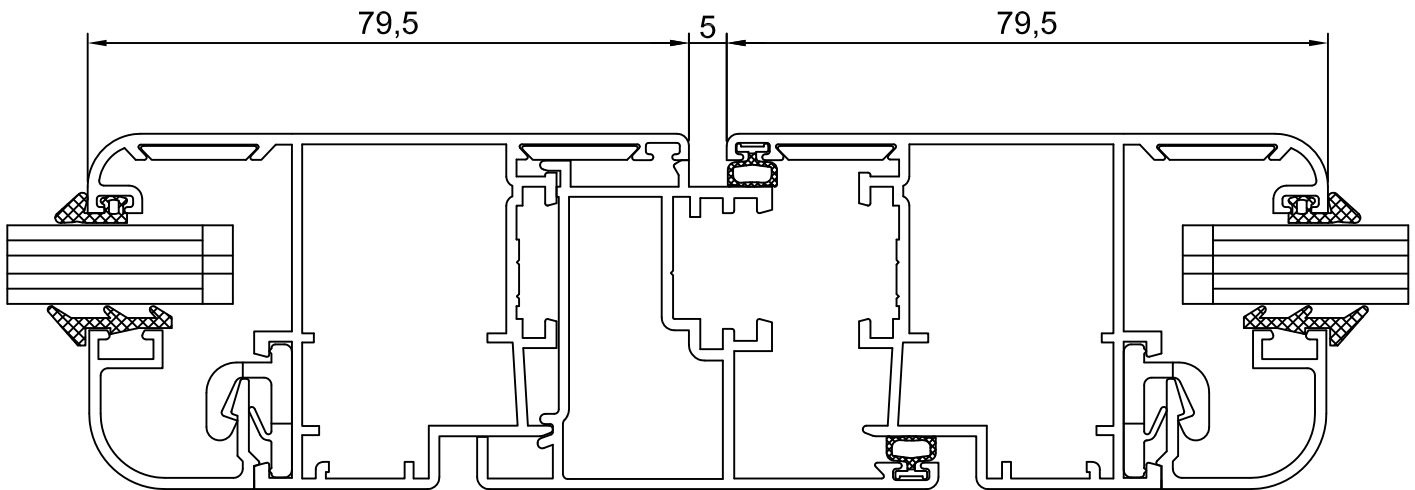
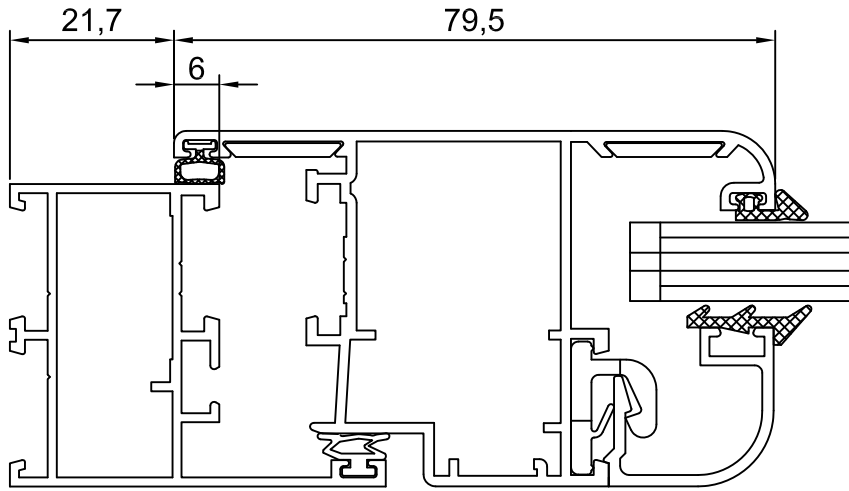

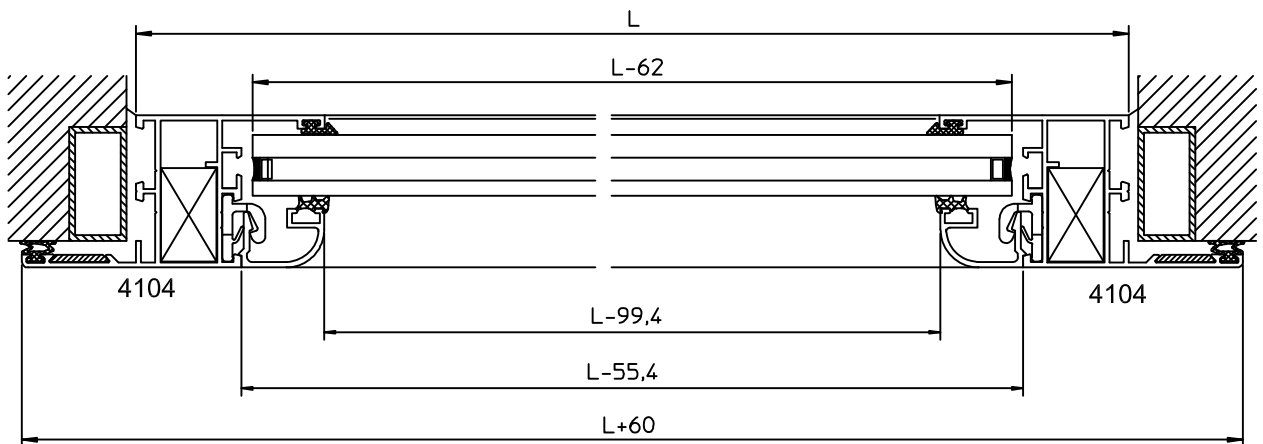
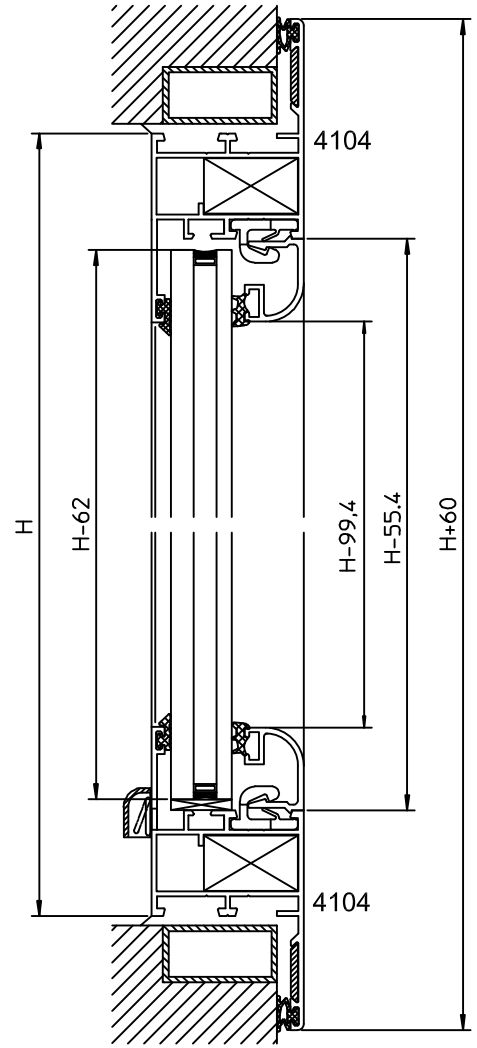
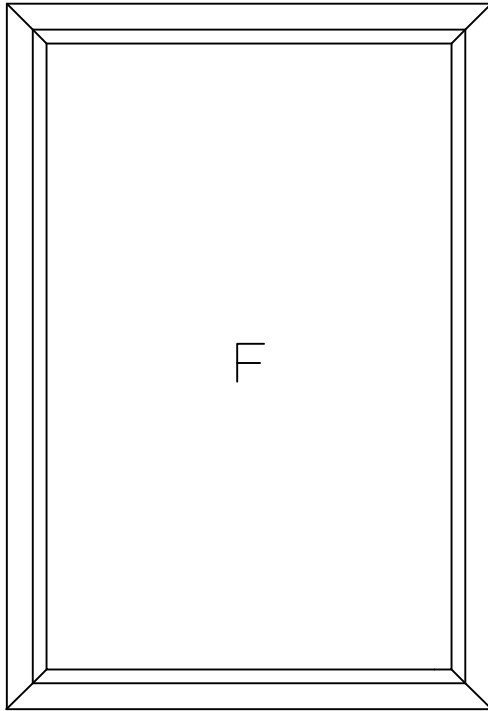

## TABLA DE LONGITUDES DE CORTE

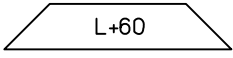
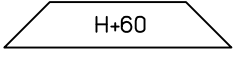
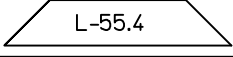
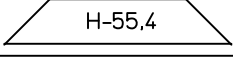
PERFIL N°	DENOMINACION	UNIDADES	LONGITUD DE CORTE EN MM.
4104	Cerco horizontal	2	 L+60
4104	Cerco vertical	2	 H+60
*	Junquillo horizontal	2	 L-55.4
*	Junquillo vertical	2	 H-55.4

\* Para junquillos, ver hoja de acristalamiento. Junquillos curvos corte a inglete y diferente medida.

## ACCESORIOS, BURLETES Y VIDRIOS

CODIGO	DENOMINACION	REFERENCIA FABRICANTE	UNIDADES	DIMENSION
	Escuadra mecanica 25x15	0443	4	
	Escuadra alineamiento	1200	4	
	Válvula de drenaje	T950	2	
	Burlete perimetral de cerco	442.010.E2	4	2(L+60) 2(H+60)
	Burlete acristalamiento exterior		4	2(L+89) 2(H+89)
	Burlete acristalamiento interior		4	2(L+78) 2(H+78)
	Herrajes y bisagras (según catálogo proveedor)			

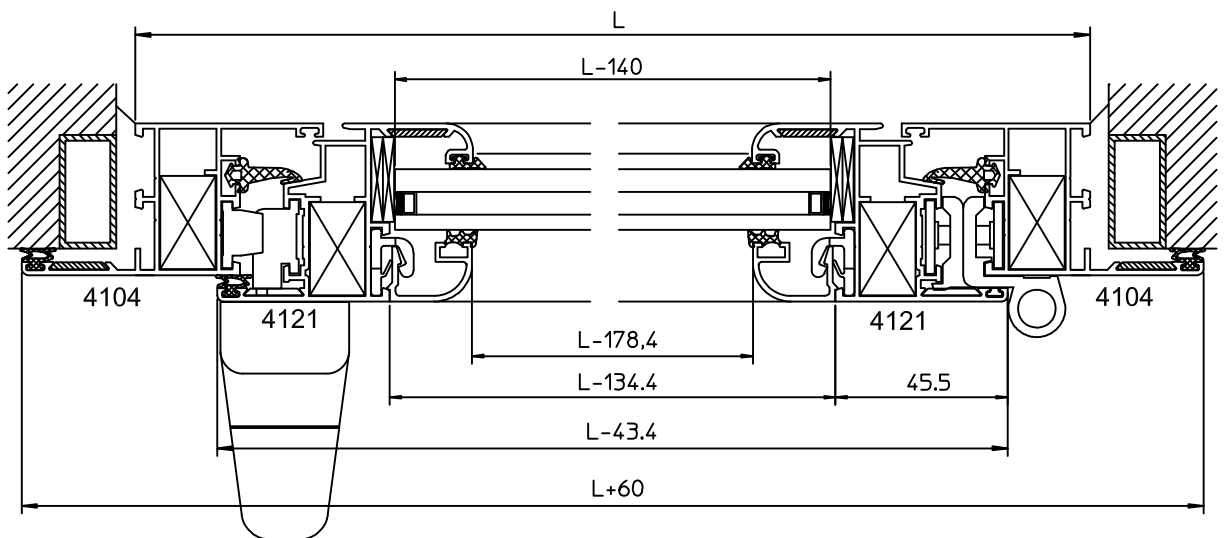
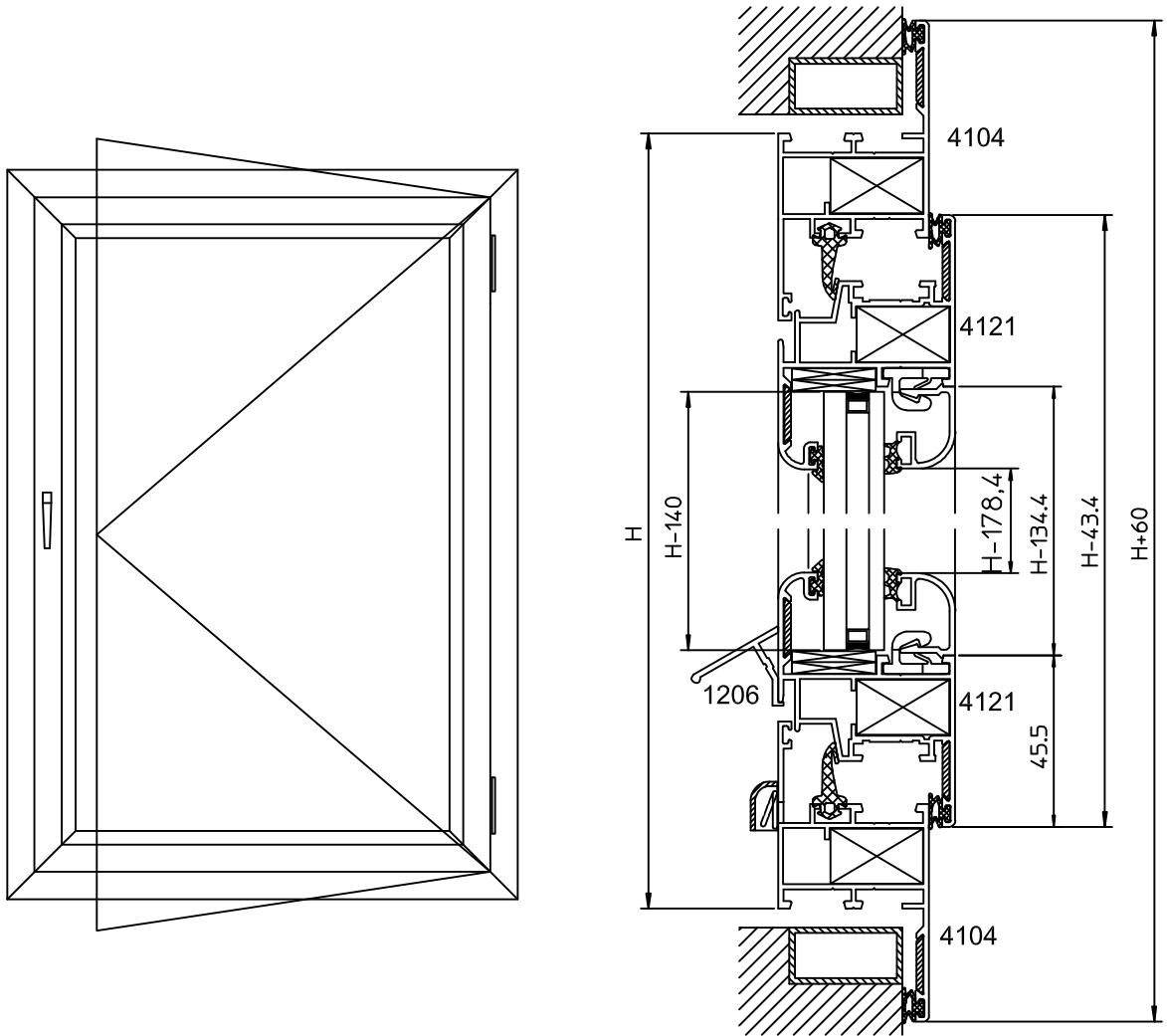

## TABLA DE LONGITUDES DE CORTE

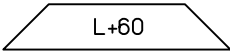
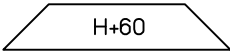
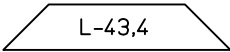
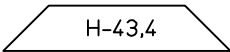
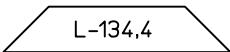
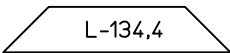
PERFIL N°	DENOMINACION	UNIDADES	LONGITUD DE CORTE EN MM.
4104	Cerco horizontal	2	 L+60
4104	Cerco vertical	2	 H+60
4121	Hoja horizontal	2	 L-43,4
4121	Hoja vertical	2	 H-43,4
*	Junquillo horizontal	2	 L-134,4
*	Junquillo vertical	2	 L-134,4
1206	Vierteaguas (opcional)	1	

\* Para junquillos, ver hoja de acristalamiento. Junquillos curvos corte a inglete y diferente medida.

## ACCESORIOS, BURLETES Y VIDRIOS

CODIGO	DENOMINACION	REFERENCIA FABRICANTE	UNIDADES	DIMENSION
	Escuadra mecanica 25x15	0443	8	
	Escuadra alineamiento	1200	12	
	Válvula de drenaje	T950	2	
	Junta central	522.190.E1	4	2(L-48) 2(H-48)
	Burlete perimetral de cerco	442.010.E2	4	2(L+60) 2(H+60)
	Burlete perimetral de hoja	309.043.TP	4	2(L-42) 2(H+42)
	Burlete acristalamiento exterior		4	2(L-168) 2(H+168)
	Burlete acristalamiento interior		4	2(L-156) 2(H+156)
	Herrajes y bisagras (según catálogo proveedor)			



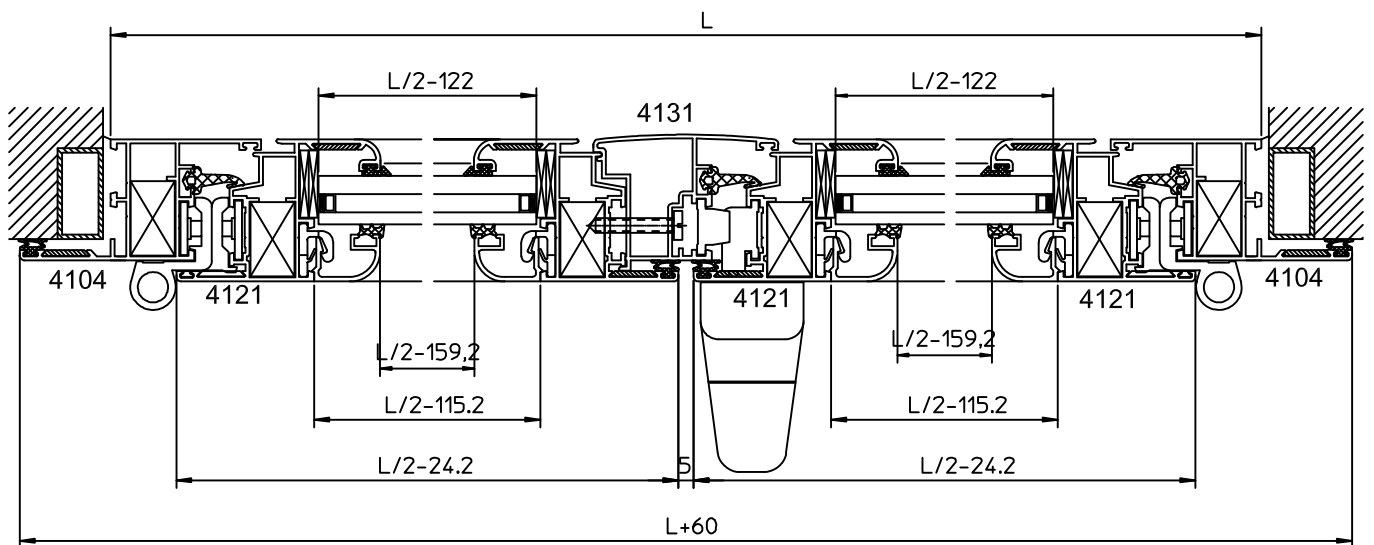
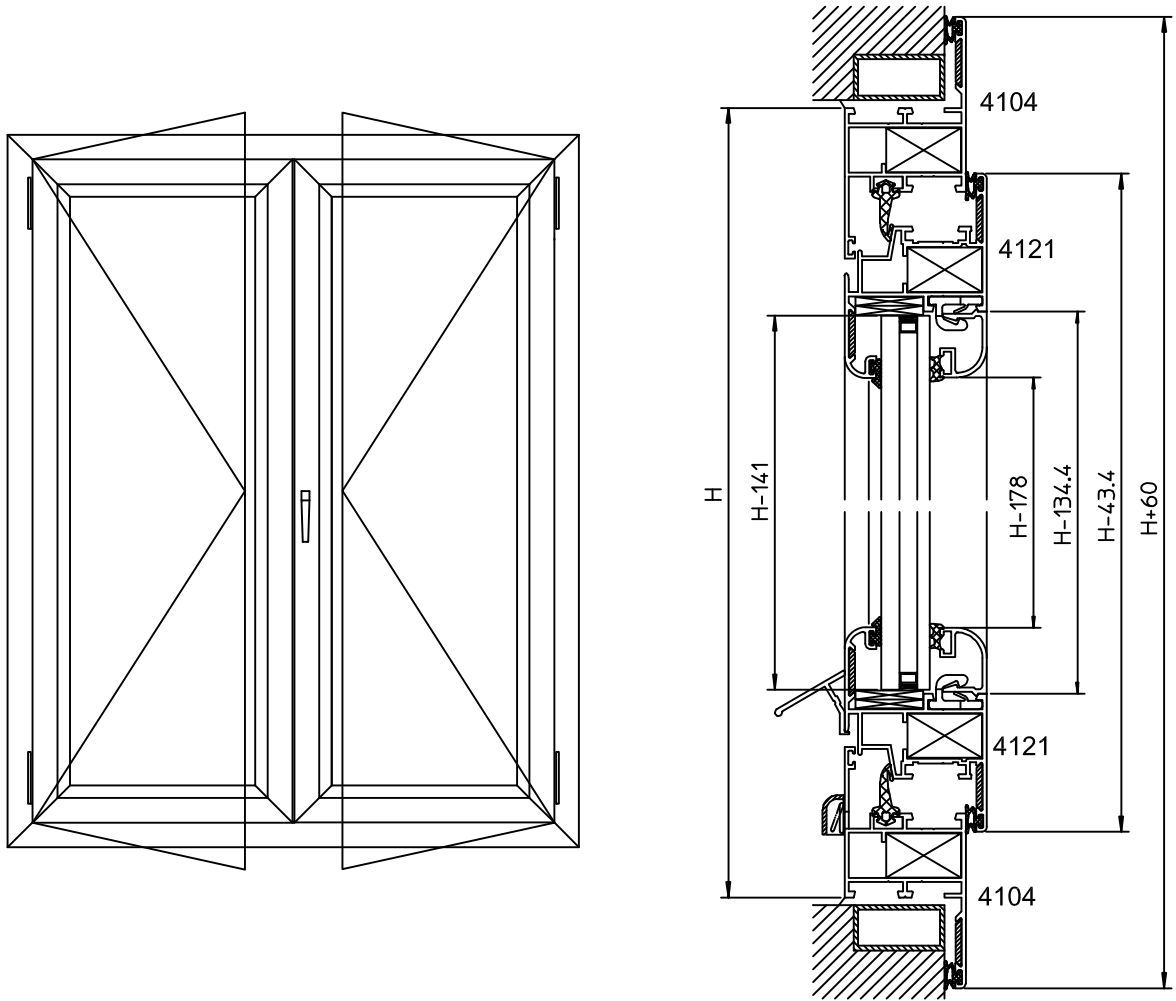

## TABLA DE LONGITUDES DE CORTE

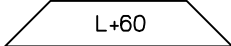
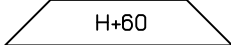
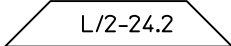
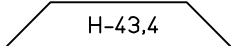
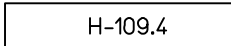
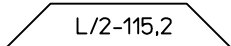
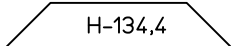
PERFIL N°	DENOMINACION	UNIDADES	LONGITUD DE CORTE EN MM.
4104	Cerco horizontal	2	 L+60
4104	Cerco vertical	2	 H+60
4121	Hoja horizontal	4	 L/2-24.2
4121	Hoja vertical	4	 H-43,4
4131	Inversor	1	 H-109,4
*	Junquillo horizontal	4	 L/2-115,2
*	Junquillo vertical	4	 H-134,4
1206	Vierteaguas (opcional)	2	

\* Para junquillos, ver hoja de acristalamiento. Junquillos curvos corte a inglete y diferente medida.

## ACCESORIOS, BURLETES Y VIDRIOS

CODIGO	DENOMINACION	REFERENCIA FABRICANTE	UNIDADES	DIMENSION
	Escuadra mecanica 25x15	0443	12	
	Escuadra alineamiento	1200	20	
	Tapa estanquidad inversor 4131	INE1903	2	
	Válvula de drenaje	T950	2	
	Junta central cercos	522.190.E1	4	2(H-48) 2(L-48)
	Junta central inversor	522.190.E1	1	H-109,4
	Burlete perimetral de cerco	442.010.E2	4	2(H+60) 2(L+60)
	Burlete perimetral de hoja	309.043.TP	8	4(H-43,4) 4(L/2-24,2)
	Burlete acristalamiento exterior		8	4(H-168) 4(L/2-120)
	Burlete acristalamiento interior		8	4(H-168) 4(L/2-120)
	Herrajes y bisagras (según catálogo proveedor)			

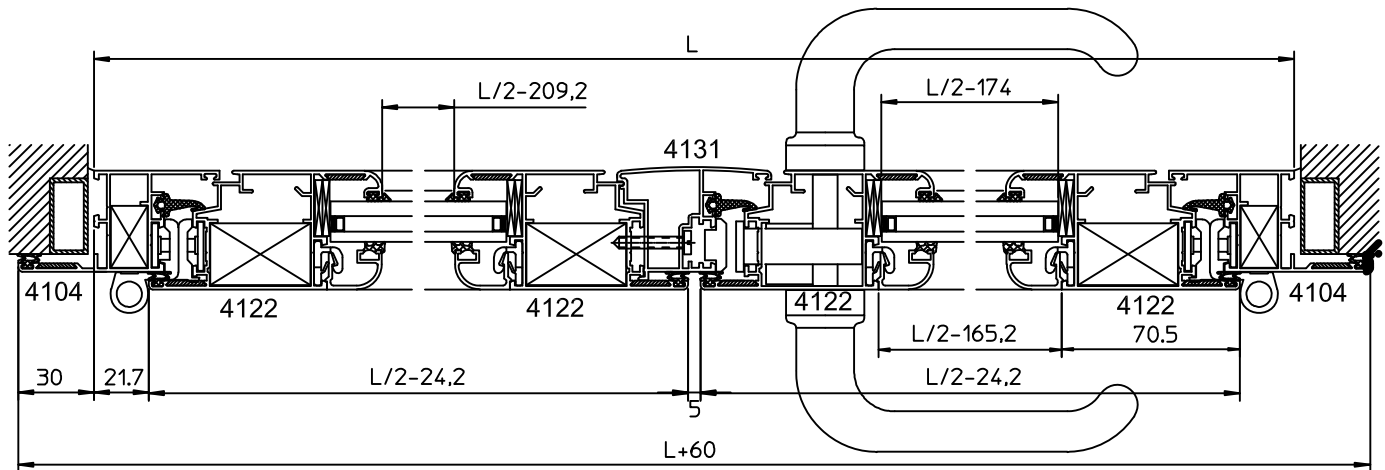
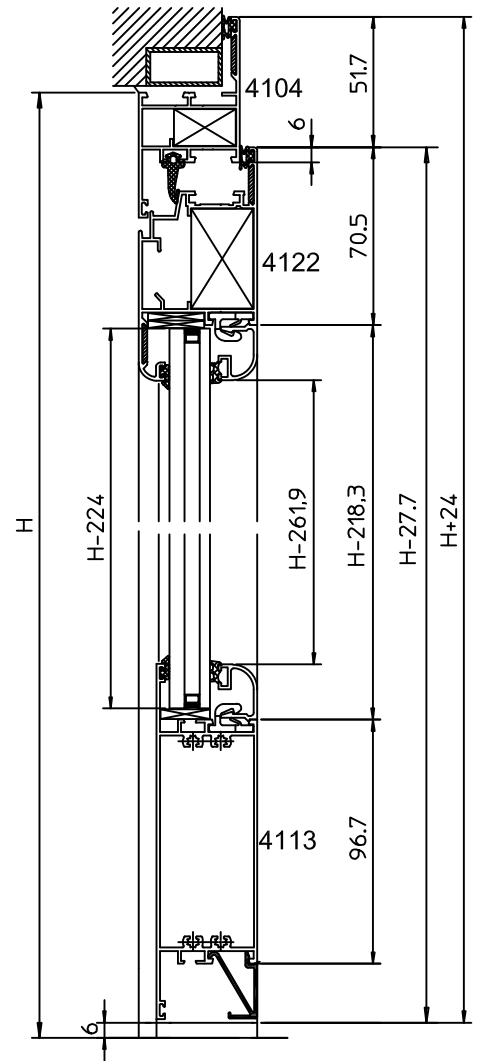
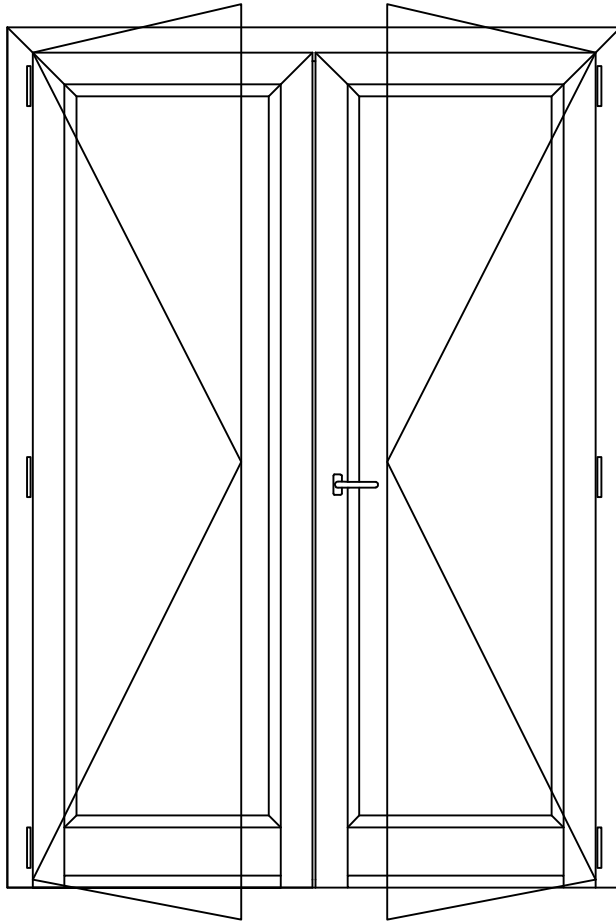

## TABLA DE LONGITUDES DE CORTE

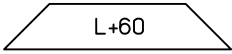
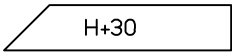
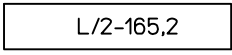
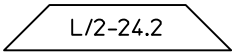
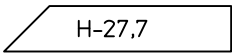
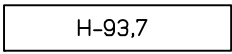
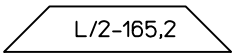
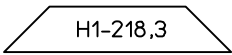
PERFIL N°	DENOMINACION	UNIDADES	LONGITUD DE CORTE EN MM.
4104	Cerco horizontal	1	
4104	Cerco vertical	2	
4113	Zocalo 140,7x40	2	
4122	Hoja horizontal	2	
4122	Hoja vertical	4	
4131	Inversor	1	
*	Junquillo horizontal pract.	4	
*	Junquillo vertical pract.	4	

\* Para Junquillos, ver hoja de acristalamiento. Junquillos curvos, rectos y diferentes medidas.

## ACCESORIOS, BURLETES Y VIDRIOS

CODIGO	DENOMINACION	REFERENCIA FABRICANTE	UNIDADES	DIMENSION
	Escuadra mecanica 25x15	0443	4	
	Escuadra mecanica 40x15	0446	8	
	Escuadra de alineamiento	1200	10	
	Tapa estanquidad inversor 65782	INE1903	2	
	Junta central cercos	522.190.E1	4	1(L-46) 2(H-23)
	Junta central inversor	522.190.E1	1	H-93,7
	Burlete perimetral de cerco	442.010.E2	3	1(L+60) 2(H+30)
	Burlete perimetral de hoja	309.043.TP	6	2(L/2-24,5) 4(H-28)
	Burlete acristalamiento exterior		8	4(L/2-199) 4(H-252)
	Burlete acristalamiento interior		8	2(L/2-187) 4(H-240)
	Herrajes y bisagras (según catálogo proveedor)			